

Title:

Additional Test report
Relating to the Fire
Resistance Performance
Of Six Specimens Of Wall
Mounted And Six
Specimens Of Floor
Mounted Linear Gap
Sealing Systems, Tested
In Accordance With BS
EN 1366-4: 2006

Report No:

187564



Prepared for:

Firestopit Limited

Westminster Ind. Est.
Tamworth Road
Measham
DE12 7DS

Date:

9th October 2009

Note: This report is additional to that issued as WF Report No. 181970 and dated 1st May 2009. The original report remains valid and is not replaced by this additional report.

Notified Body No:

0833



Summary

Objective A fire resistance test has been conducted to assess the ability of six vertically orientated specimens and six horizontally orientated specimens of linear gap sealing systems, to reinstate the fire resistance of a blockwork wall and a pre-cast, aerated concrete floor incorporating timber and mild steel sections when tested in accordance with BS EN 1366-4: 2006.

Sponsor **Firestopit Limited**, Westminster Ind. Est., Tamworth Road, Measham, DE12 7DS

Summary of the Tested Specimen For the purpose of the test the floor specimens were referenced A to F and the wall specimens were referenced G to L.

The section of wall had overall dimensions of 1500 mm high by 1500 mm wide by 150 mm thick and was made up of aerated blockwork arranged to provide four 12 mm wide by 1000 mm long and two 30 mm wide by 1000 mm long linear gaps.

The section of floor had overall dimensions of 2240 mm long by 1730 mm wide by 150 mm thick and was made up of autoclaved aerated concrete lintels arranged to provide two 12 mm wide by 1000 mm long, two 30 mm wide by 1000 mm long and two 50 mm wide by 1000 mm long linear gaps.

Each gap was sealed with silicone based intumescent sealant referenced "Pyrolastic Fire Rated Silicone". Each seal was cartridge gunned into the gaps. Specimens I and J incorporated a softwood timber gap facing, Specimen K incorporated a hardwood timber gap facing and Specimens D, E, F and L incorporated a mild steel angle gap facing. Specific details of each of the seals are given in the table below:

Specimen	Gap width	Gap Depth
A	12 mm	6 mm deep, cartridge gunned then trowelled flush with the unexposed face and faced on the exposed side with 13 mm diameter polyethylene backing rod
B	30 mm	15 mm deep, cartridge gunned then trowelled flush with the unexposed face and faced on the exposed side with 30 mm diameter polyethylene backing rod
C	50 mm	25 mm deep, cartridge gunned then trowelled flush with the unexposed face and faced on the exposed side with 2 no. 25 mm diameter polyethylene backing rod

Specimen	Gap width	Gap Depth
D	12 mm	6 mm deep, cartridge gunned then trowelled flush with the unexposed face and faced on the exposed side with 13 mm diameter polyethylene backing rod
E	30 mm	15 mm deep, cartridge gunned then trowelled flush with the unexposed face and faced on the exposed side with 30 mm diameter polyethylene backing rod
F	50 mm	25 mm deep, cartridge gunned then trowelled flush with the unexposed face and faced on the exposed side with 2 no. 25 mm diameter polyethylene backing rod
G	12 mm	6 mm deep, cartridge gunned then trowelled flush with both faces of the cavity. Both unexposed and exposed gap seals were faced internally with 13 mm diameter polyethylene backing rods
H	30 mm	15 mm deep, cartridge gunned then trowelled flush with both faces of the cavity. Both unexposed and exposed gap seals were faced internally with 30 mm diameter polyethylene backing rods
I	12 mm	6 mm deep, cartridge gunned then trowelled flush with both faces of the cavity. Both unexposed and exposed gap seals were faced internally with 13 mm diameter polyethylene backing rods
J	30 mm	15 mm deep, cartridge gunned then trowelled flush with both faces of the cavity. Both unexposed and exposed gap seals were faced internally with 30 mm diameter polyethylene backing rods
K	12 mm	6 mm deep, cartridge gunned then trowelled flush with both faces of the cavity. Both unexposed and exposed gap seals were faced internally with 13 mm diameter polyethylene backing rods
L	12 mm	6 mm deep, cartridge gunned then trowelled flush with both faces of the cavity. Both unexposed and exposed gap seals were faced internally with 13 mm diameter polyethylene backing rods

Full details of the specimens and installation methods are given in the Schedule of Components.

Test Results

Reference	Integrity (mins)		Insulation (mins)
	Cotton Pad	Sustained flaming	
A	244	300*	122
B	300*	300*	186
C	246	300*	65
D	300*	300*	48
E	300*	300*	43
F	229	300*	33
G	300*	300*	300*
H	300*	300*	300*
I	199	199	145
J	143	143	143
K	208	208	208
L	300*	300*	69

* The test duration. The test was discontinued after a period of 300 minutes.

Date of Test

24th April 2009

This report may only be reproduced in full. Extracts or abridgements of reports shall not be published without permission of Bodycote warringtonfire

Signatories

Responsible Officer D. Yates* Testing Officer

Approved C. Johnson* Senior Certification Engineer

Head of Department S. Hankey* Operations Manager

* For and on behalf of Bodycote **warringtonfire**.

Report Issued
Date : 9th October 2009

This version of the report has been produced from a .pdf format electronic file that has been provided by Bodycote warringtonfire to the sponsor of the report and must only be reproduced in full. Extracts or abridgements of reports must not be published without permission of Bodycote warringtonfire. The original signed paper version of this report, which includes signatures in blue ink, is the sole authentic version. Only original paper versions of this report bear authentic signatures of the responsible Bodycote warringtonfire staff.

Note: This report is additional to that issued as WF Report No. 181970 and dated 1st May 2009. The original report remains valid and is not replaced by this additional report.

CONTENTS	PAGE NO.
SUMMARY	2
SIGNATORIES	5
TEST PROCEDURE	7
TEST SPECIMEN	8
SCHEDULE OF COMPONENTS	17
INSTRUMENTATION	22
TEST OBSERVATIONS	23
TEST PHOTOGRAPHS	26
TEMPERATURE DATA	35
PERFORMANCE CRITERIA AND TEST RESULTS	50
ONGOING IMPLICATIONS	51
CONCLUSIONS	51
FIELD OF DIRECT APPLICATION	52

Test Procedure

Introduction	<p>Walls and floors often incorporate gaps to accommodate expansion, contraction or other movement of the structure. The fire resistance of such elements is only as good as their weakest point and it is, therefore, important that any gaps or apertures are adequately sealed, such that weaknesses are not created at these positions.</p> <p>The specimens were judged on their ability to comply with the performance criteria for integrity and insulation, as required by BS EN 1366-4: 2006.</p>
Fire Test Study Group/EGOLF	<p>Certain aspects of some fire test specifications are open to different interpretations. The Fire Test Study Group and EGOLF have identified a number of such areas and have agreed Resolutions which define common agreement of interpretations between fire test laboratories which are members of the Groups. Where such Resolutions are applicable to this test they have been followed.</p>
Instruction To Test	<p>The test was conducted on the 24th April 2009 at the request of the original sponsor of the test.</p> <p>The test was witnessed by Mr. G. Southerington, Mr. P. Thomas, Mr. G. Hepworth and Mr. C. Abbott.</p>
Test Specimen Construction	<p>A comprehensive description of the test construction is given in the Schedule of Components. The description is based on a detailed survey of the specimens and information supplied by the sponsor of the test.</p>
Installation	<p>Bodycote warringtonfire supplied the wall and floor constructions. The gap sealing systems were provided and installed by a representative of the test sponsor on the 20th March 2009.</p>
Sampling	<p>A representative of Warrington Certification Limited selected and sampled the intumescent seals on the 11th March 2009.</p>
Conditioning	<p>The specimens' storage, construction, and test preparation took place in the test laboratory over a total, combined time of 35 days. Throughout this period of time both the temperature and the humidity of the laboratory were measured and recorded as being within a range of from 10°C to 26°C and 30% to 72% respectively.</p>

Test Specimen

Figure 1- General Plan of Floor Test Specimens from Unexposed Face

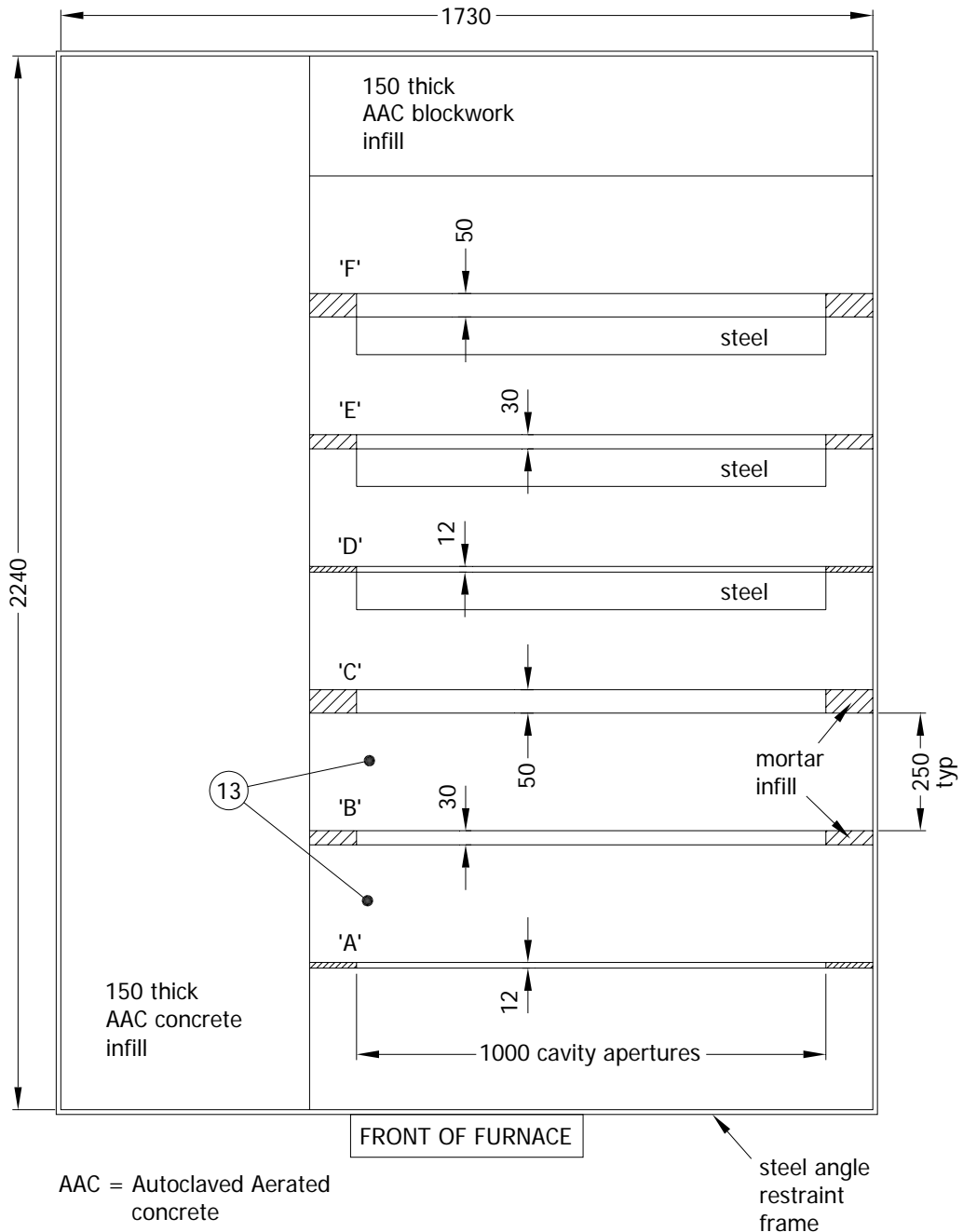

Do not scale. All dimensions are in mm

Figure 2 – Enlarged View showing Unexposed Face Thermocouples for Floor Test Specimens

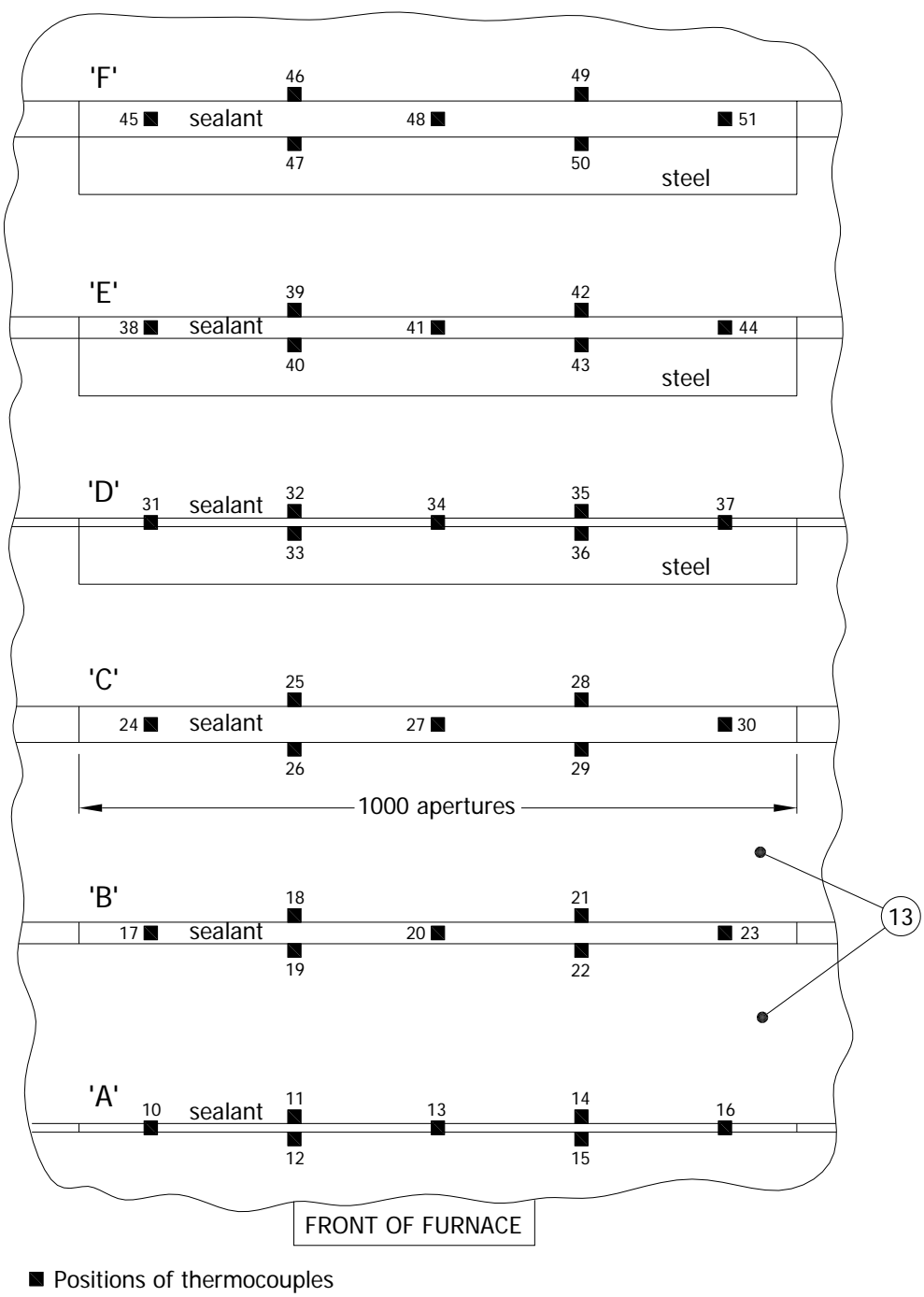

Do not scale. All dimensions are in mm

Figure 3 – Section Through Floor Specimens 'A' and 'B' (items 1 and 2)

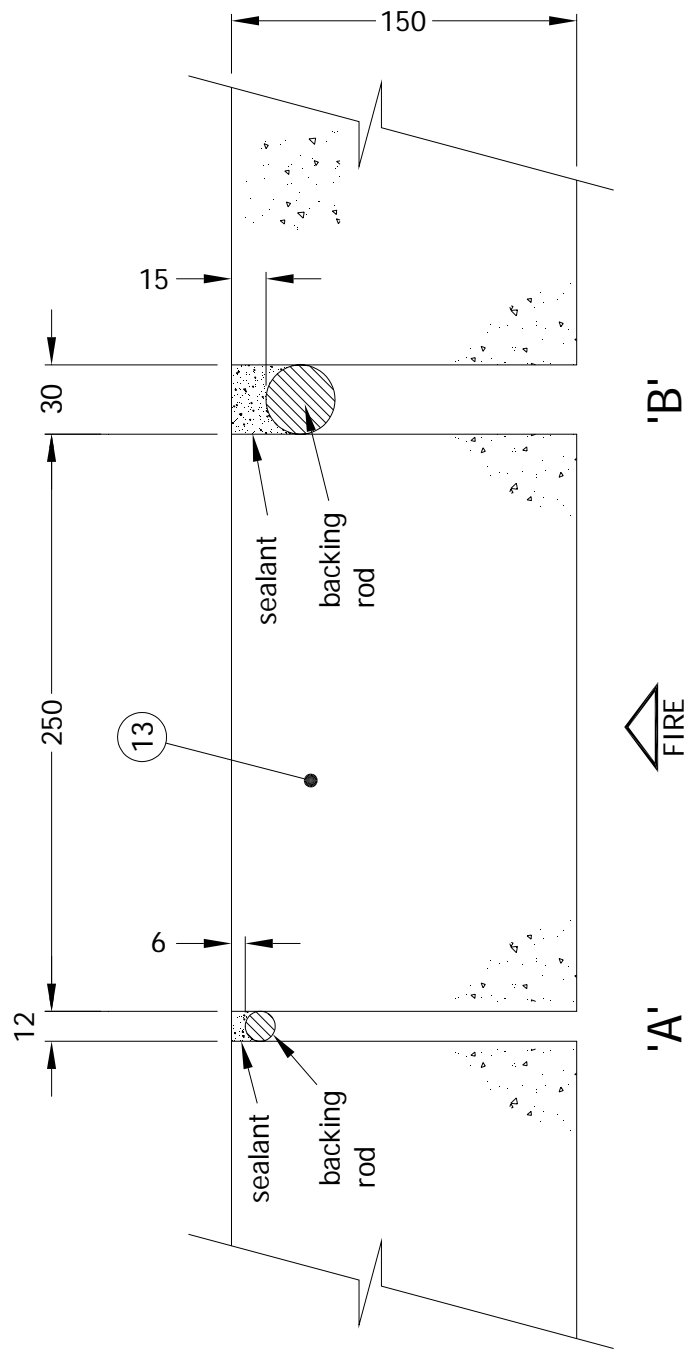

Do not scale. All dimensions are in mm

Figure 4 – Section Through Floor Specimens 'C' and 'D' (items 3 and 4)

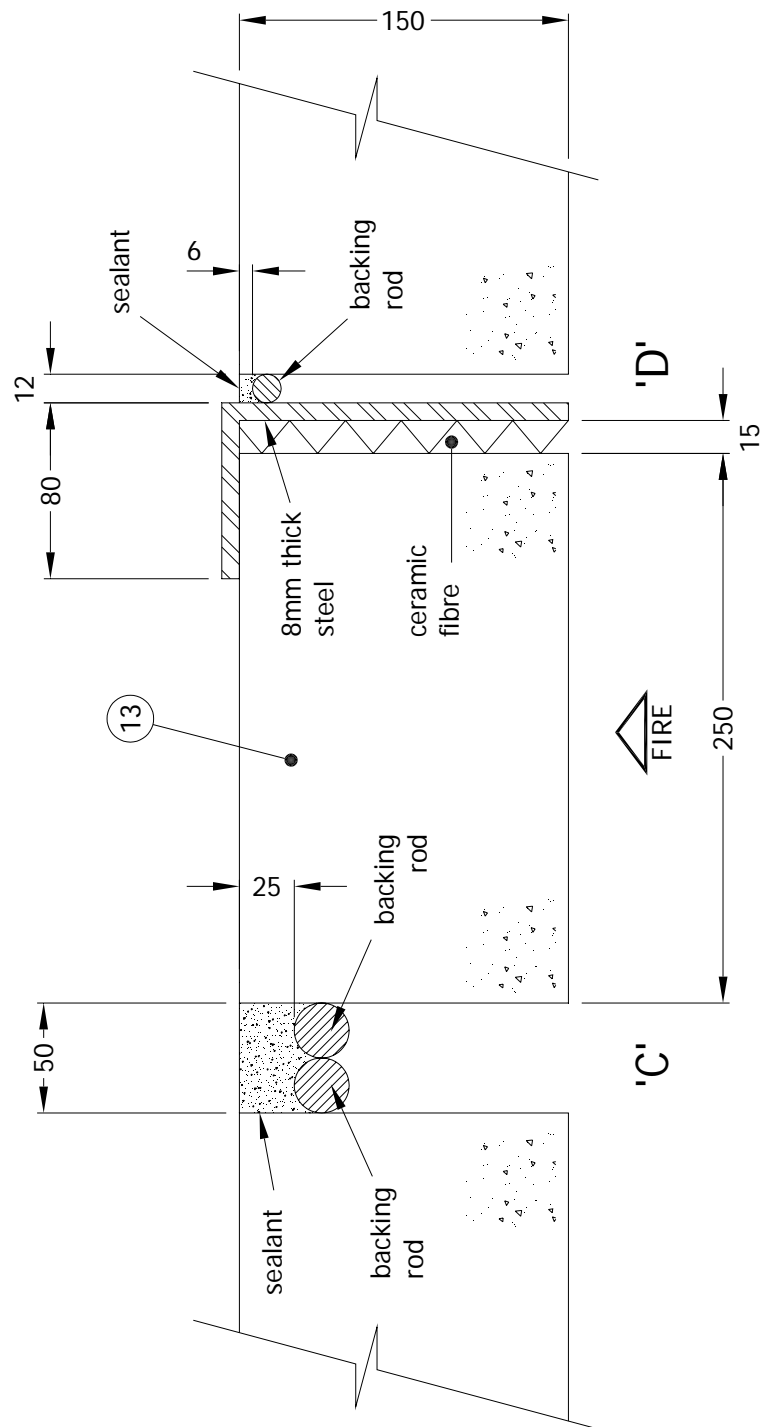

Do not scale. All dimensions are in mm

Figure 5 – Section Through Floor Specimens 'E' and 'F' (items 5 and 6)

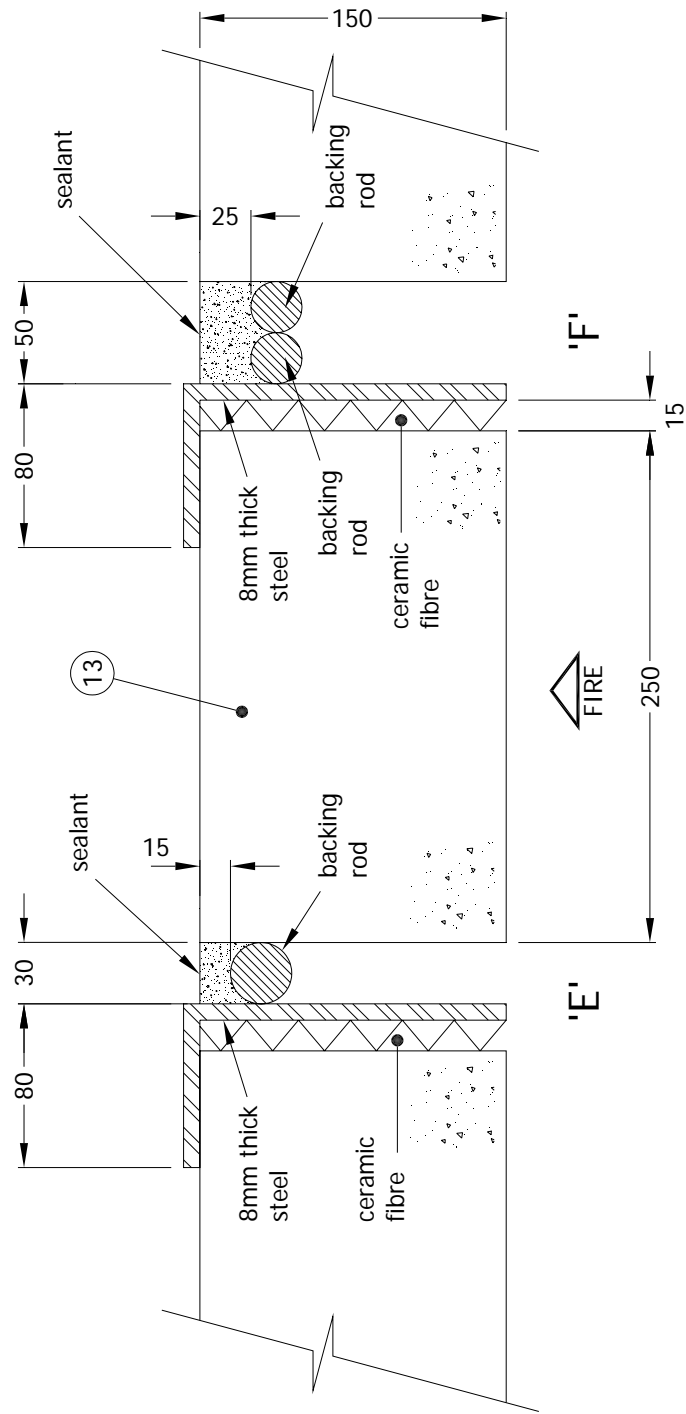

Do not scale. All dimensions are in mm

Figure 6 – General Elevation of Wall Test Specimens and Thermocouples at Unexposed Face

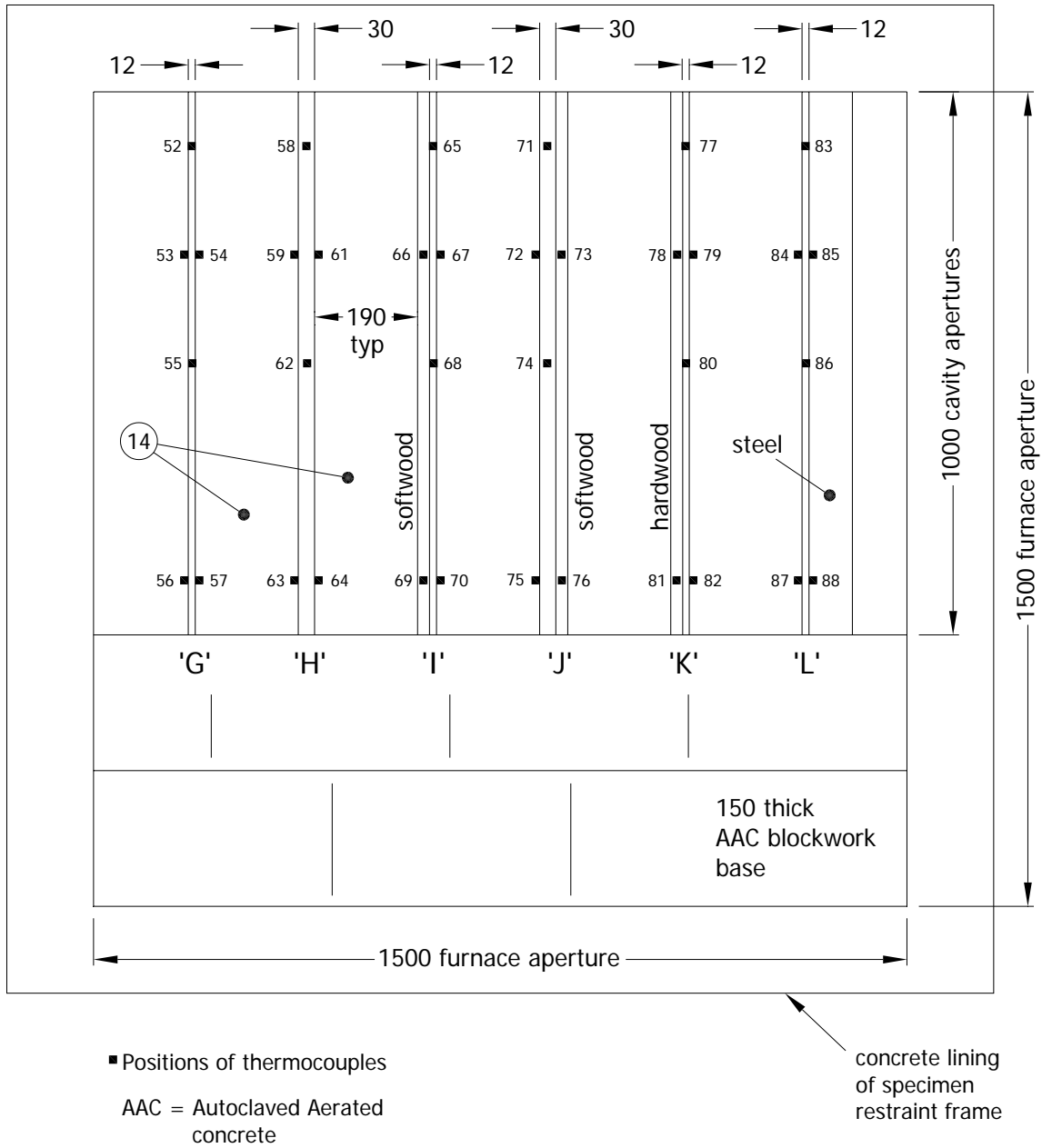

Do not scale. All dimensions are in mm

Figure 7 – Section Through Wall Specimens 'G' and 'H' (items 7 and 8)

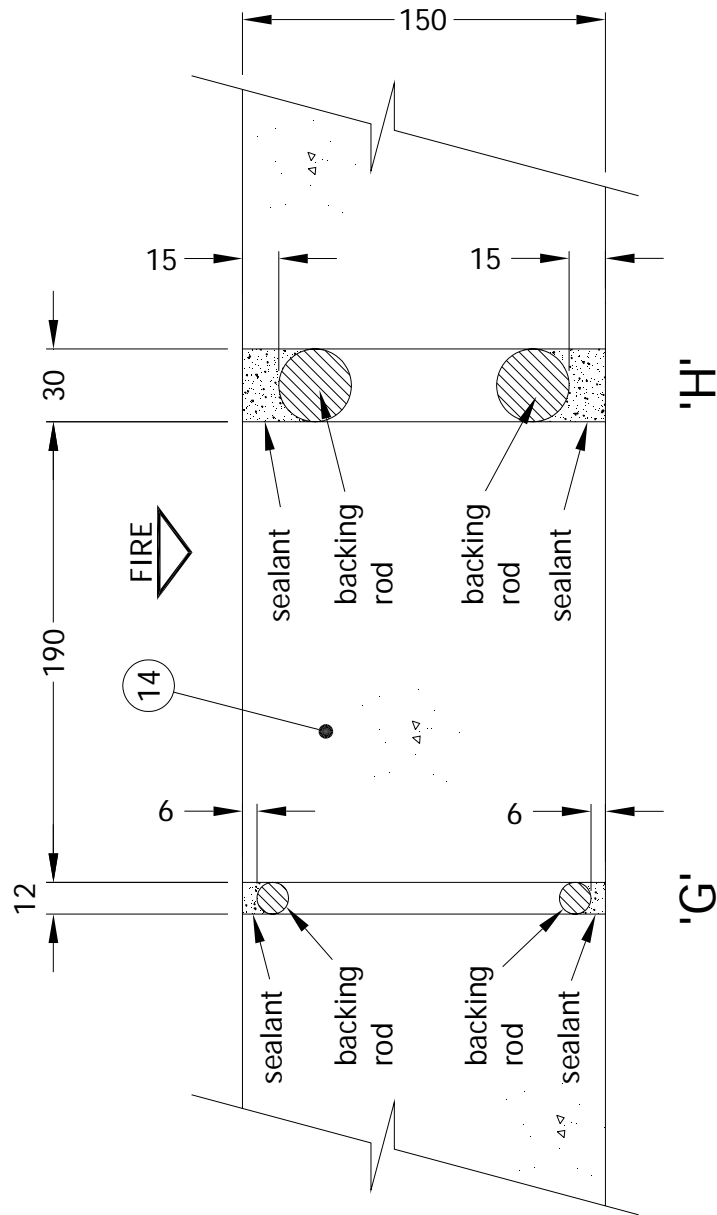

Do not scale. All dimensions are in mm

Figure 8 – Section Through Wall Specimens 'I' and 'J' (items 9 and 10)

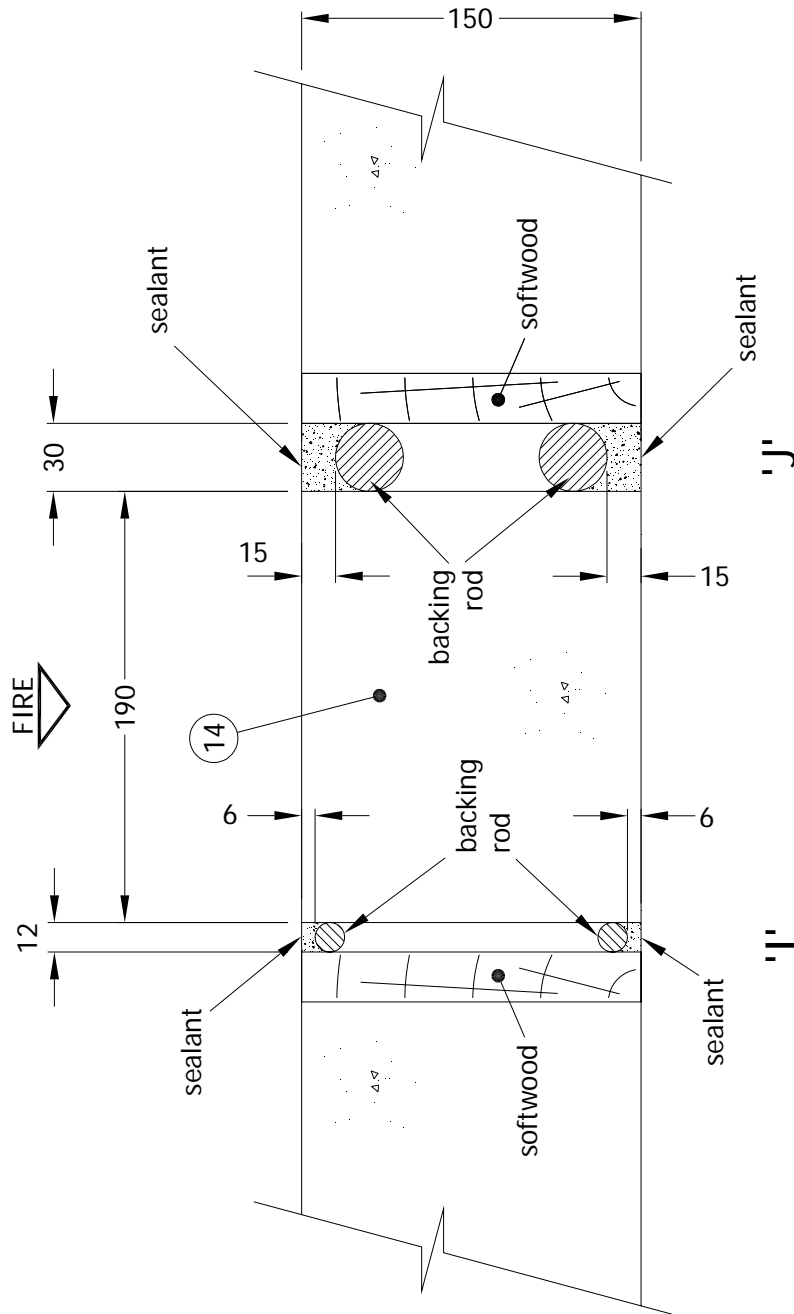

Do not scale. All dimensions are in mm

Figure 9 – Section Through Wall Specimens 'K' and 'L' (items 11 and 12)

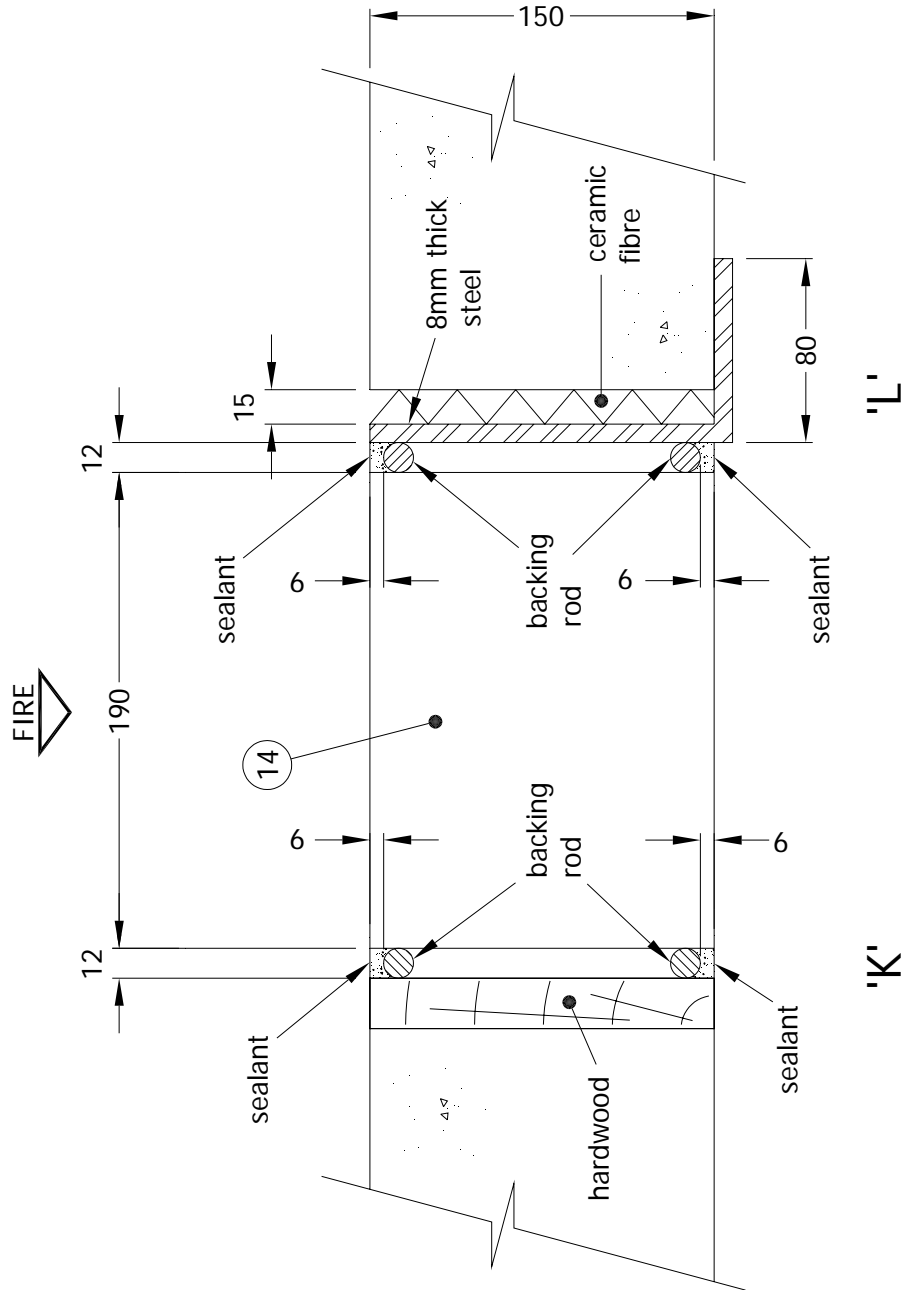

Do not scale. All dimensions are in mm

Schedule of Components

(Refer to Figures 1 to 9)

(All values are nominal unless stated otherwise)

(All other details are as stated by the sponsor)

<u>Item</u>	<u>Description</u>
Details of Floor Cavity Barriers (items 1 to 6)	
1. Specimen 'A'	
Details of Sealant	
Supplier	: Firestopit Limited
Reference	: Pyrolastic Fire Rated Silicone
Material	: Silicone Sealant
Overall section size of sealant	: 12 mm wide x 6 mm deep x 1000 mm long
Application method	: Cartridge gunned at unexposed face of cavity
Overall size of cavity	: 12 mm wide x 150 mm deep x 1000 mm long
Details of Backing rod	
Material	: Polyethylene
Size	: 13 mm diameter
Fixing method	: Friction fit within cavity
Details of Gap facing	: Masonry (item 13)
2. Specimen 'B'	
Details of Sealant	
Supplier	: Firestopit Limited
Reference	: Pyrolastic Fire Rated Silicone
Material	: Silicone Sealant
Overall section size of sealant	: 30 mm wide x 15 mm deep x 1000 mm long
Application method	: Cartridge gunned at unexposed face of cavity
Overall size of cavity	: 30 mm wide x 150 mm deep x 1000 mm long
Details of Backing rod	
Material	: Polyethylene
Size	: 30 mm diameter
Fixing method	: Friction fit within cavity
Details of Gap facing	: Masonry (item 13)
3. Specimen 'C'	
Details of Sealant	
Supplier	: Firestopit Limited
Reference	: Pyrolastic Fire Rated Silicone
Material	: Silicone Sealant
Overall section size of sealant	: 50 mm wide x 25 mm deep x 1000 mm long
Application method	: Cartridge gunned at unexposed face of cavity
Overall size of cavity	: 50 mm wide x 150 mm deep x 1000 mm long
Details of Backing rod	
Material	: Polyethylene
Size	: 2 no. rods, each 25 mm diameter
Fixing method	: Friction fit within cavity
Details of Gap facing	: Masonry (item 13)

<u>Item</u>	<u>Description</u>
4. Specimen 'D'	
Details of Sealant	
Supplier	: Firestopit Limited
Reference	: Pyrolastic Fire Rated Silicone
Material	: Silicone Sealant
Overall section size of sealant	: 12 mm wide x 6 mm deep x 1000 mm long
Application method	: Cartridge gunned at unexposed face of cavity
Overall size of cavity	: 12 mm wide x 150 mm deep x 1000 mm long
Details of Backing rod	
Material	: Polyethylene
Size	: 13 mm diameter
Fixing method	: Friction fit within cavity
Details of Gap facing	
Details of steel	
Thickness	: 8 mm
Fixing method to masonry	: 3 no. 5.5 mm diameter x 75 mm long screws
Details of insulation infill	
Material	: Ceramic fibre insulation
Fixing method	: Friction fit within void behind steel facing. See Figure 4.
5. Specimen 'E'	
Details of Sealant	
Supplier	: Firestopit Limited
Reference	: Pyrolastic Fire Rated Silicone
Material	: Silicone Sealant
Overall section size of sealant	: 30 mm wide x 15 mm deep x 1000 mm long
Application method	: Cartridge gunned at unexposed face of cavity
Overall size of cavity	: 30 mm wide x 150 mm deep x 1000 mm long
Details of Backing rod	
Material	: Polyethylene
Size	: 30 mm diameter
Fixing method	: Friction fit within cavity
Details of Gap facing	
Details of steel	
Thickness	: 8 mm
Fixing method to masonry	: 3 no. 5.5 mm diameter x 75 mm long screws
Details of insulation infill	
Material	: Ceramic fibre insulation
Fixing method	: Friction fit within void behind steel facing. See Figure 5.
6. Specimen 'F'	
Details of Sealant	
Supplier	: Firestopit Limited
Reference	: Pyrolastic Fire Rated Silicone
Material	: Silicone Sealant
Overall section size of sealant	: 50 mm wide x 25 mm deep x 1000 mm long
Application method	: Cartridge gunned at unexposed face of cavity
Overall size of cavity	: 50 mm wide x 150 mm deep x 1000 mm long
Details of Backing rod	
Material	: Polyethylene
Size	: 2 no. rods, each 25 mm diameter

<u>Item</u>	<u>Description</u>
6. continued	
Fixing method	: Friction fit within cavity
Details of Gap facing	: Steel/Masonry (item 13)
Details of steel	
Thickness	: 8 mm
Fixing method to masonry	: 3 no. 5.5 mm diameter x 75 mm long screws
Details of insulation infill	
Material	: Ceramic fibre insulation
Fixing method	: Friction fit within void behind steel facing. See Figure 5.

Details of Wall Cavity Barriers (items 7 to 12)

7. Specimen 'G'

Details of Sealant	
Supplier	: Firestopit Limited
Reference	: Pyrolastic Fire Rated Silicone
Material	: Silicone Sealant
Overall section size of sealant	: 12 mm wide x 6 mm deep x 1000 mm long
Application method	: Cartridge gunned at both faces of cavity
Overall size of cavity	: 12 mm wide x 150 mm deep x 1000 mm long
Details of Backing rod	
Material	: Polyethylene
Size	: 13 mm diameter
Fixing method	: Friction fit within cavity
Details of Gap facing	: Masonry (item 14)

8. Specimen 'H'

Details of Sealant	
Supplier	: Firestopit Limited
Reference	: Pyrolastic Fire Rated Silicone
Material	: Silicone Sealant
Overall section size of sealant	: 30 mm wide x 15 mm deep x 1000 mm long
Application method	: Cartridge gunned at both faces of cavity
Overall size of cavity	: 30 mm wide x 150 mm deep x 1000 mm long
Details of Backing rod	
Material	: Polyethylene
Size	: 30 mm diameter
Fixing method	: Friction fit within cavity
Details of Gap facing	: Masonry (item 14)

9. Specimen 'I'

Details of Sealant	
Supplier	: Firestopit Limited
Reference	: Pyrolastic Fire Rated Silicone
Material	: Silicone Sealant
Overall section size of sealant	: 12 mm wide x 6 mm deep x 1000 mm long
Application method	: Cartridge gunned at both faces of cavity
Overall size of cavity	: 12 mm wide x 150 mm deep x 1000 mm long
Details of Backing rod	
Material	: Polyethylene
Size	: 13 mm diameter
Fixing method	: Friction fit within cavity
Details of Gap facing	: Timber/Masonry (item 14)

<u>Item</u>	<u>Description</u>
9. continued	
Details of Timber	
Material	: Softwood
Thickness	: 22 mm
Fixing method to masonry	: 6 no. screws
10. Specimen 'J'	
Details of Sealant	
Supplier	: Firestopit Limited
Reference	: Pyrolastic Fire Rated Silicone
Material	: Silicone Sealant
Overall section size of sealant	: 30 mm wide x 15 mm deep x 1000 mm long
Application method	: Cartridge gunned at both faces of cavity
Overall size of cavity	: 30 mm wide x 150 mm deep x 1000 mm long
Details of Backing rod	
Material	: Polyethylene
Size	: 30 mm diameter
Fixing method	: Friction fit within cavity
Details of Gap facing	: Timber/Masonry (item 14)
Details of Timber	
Material	: Softwood
Thickness	: 22 mm
Fixing method to masonry	: 6 no. screws
11. Specimen 'K'	
Details of Sealant	
Supplier	: Firestopit Limited
Reference	: Pyrolastic Fire Rated Silicone
Material	: Silicone Sealant
Overall section size of sealant	: 12 mm wide x 6 mm deep x 1000 mm long
Application method	: Cartridge gunned at both faces of cavity
Overall size of cavity	: 12 mm wide x 150 mm deep x 1000 mm long
Details of Backing rod	
Material	: Polyethylene
Size	: 13 mm diameter
Fixing method	: Friction fit within cavity
Details of Gap facing	: Timber/Masonry (item 14)
Details of Timber	
Material	: Hardwood
Thickness	: 22 mm
Fixing method to masonry	: 6 no. screws
12. Specimen 'L'	
Details of Sealant	
Supplier	: Firestopit Limited
Reference	: Pyrolastic Fire Rated Silicone
Material	: Silicone Sealant
Overall section size of sealant	: 12 mm wide x 6 mm deep x 1000 mm long
Application method	: Cartridge gunned at both faces of cavity
Overall size of cavity	: 12 mm wide x 150 mm deep x 1000 mm long

<u>Item</u>	<u>Description</u>
12. continued	
Details of Backing rod	
Material	: Polyethylene
Size	: 13 mm diameter
Fixing method	: Friction fit within cavity
Details of Gap facing	: Steel/Masonry (item 14)
Details of steel	
Thickness	: 8 mm
Fixing method to masonry	: 3 no. 5.5 mm diameter x 75 mm long screws
Details of insulation infill	
Material	: Ceramic fibre insulation
Fixing method	: Friction fit within void behind steel facing. See Figure 9.
13. Concrete Floor	
Material	: Autoclaved aerated concrete lintels
Density	: 670 kg/m ³
Thickness	: 150 mm
Bedding material	: Ordinary sand/cement mortar mix
14. Blockwork Wall	
Material	: Autoclaved aerated concrete blocks
Density	: 760 kg/m ³
Thickness	: 150 mm
Bedding material	: Ordinary sand/cement mortar mix

Instrumentation

General	The instrumentation was provided in accordance with the requirements of the Standard.
Furnace	The furnace was controlled so that its mean temperature complied with the requirements of BS EN 1363-1: 1999 Clause 5.1 using three plate thermometers, distributed over a plane 100 mm from the surface of the vertical test construction and three plate thermometers, distributed over a plane 100 mm from the surface of the horizontal test construction
Thermocouple Allocation	<p>Thermocouples were provided to monitor the unexposed surface of the specimens and the output of all instrumentation was recorded at no less than one minute intervals as follows:</p> <p>The locations and reference numbers of the various unexposed surface thermocouples are shown in Figures 2 and 6.</p>
Roving Thermocouple	A roving thermocouple was available to measure temperatures on the unexposed surface of the specimens at any position, which might appear to be hotter than the temperatures indicated by the fixed thermocouples.
Integrity Criteria	Cotton pads were available to evaluate the integrity of the specimens.
Furnace Pressure	After the first five minutes of testing, the furnace pressure was controlled to maintain a slightly positive pressure relative to the pressure of the laboratory. The furnace atmospheric pressure was measured and controlled such that, at a point at mid height of the specimens in the wall assembly, the differential pressure was calculated to be 15 (± 2) Pa. and at a position 100 mm below the underside of the floor assembly was calculated to be 20 (± 2) Pa.

Test Observations

Time		All observations are from the unexposed face unless noted otherwise.
mins	secs	The ambient air temperature in the vicinity of the test construction was 17°C at the start of the test with a maximum variation of +7°C during the test.
00	00	The test commences.
02	00	Smoke release begins to issue from the timber substrates of Specimens I, J and K.
18	00	Smoke release has reduced slightly from all specimens.
19	00	Viewed from the exposed face, flames can be seen issuing from the timber substrates of Specimens I, J and K.
22	20	Smoke release issues from behind the steel angle substrate of Specimens E & F.
30	00	No significant visible change. All specimens continue to satisfy the test criteria.
33	00	Thermocouple number 47 of Specimen F records a temperature rise in excess of 180° C. Insulation failure of Specimen F is deemed to occur.
43	00	Thermocouple number 43 of Specimen E records a temperature rise in excess of 180° C. Insulation failure of Specimen E is deemed to occur.
48	00	Thermocouple number 36 of Specimen D records a temperature rise in excess of 180° C. Insulation failure of Specimen D is deemed to occur.
60	00	All specimens continue to satisfy the integrity criteria. All specimens excluding Specimens D, E and F continue to satisfy the insulation criteria.
65	00	Thermocouple number 24 of Specimen C records a temperature rise in excess of 180° C. Insulation failure of Specimen C is deemed to occur.
69	00	Thermocouple number 88 of Specimen L records a temperature rise in excess of 180° C. Insulation failure of Specimen L is deemed to occur.
92	00	The seal to Specimens D, E and F have separated from the steel angle substrate. The seal to Specimens E and F has swollen away from the furnace chamber by approximately 10-12 mm past the steel substrate.
95	00	Smoke/steam release issues from the seal of Specimens E and F from the area of separation along the steel angled substrate. No areas of glowing or through gaps are visible within the area of separation at present.
122	00	Thermocouple number 16 of Specimen A records a temperature rise in excess of 180° C. Insulation failure of Specimen A is deemed to occur. All specimens continue to satisfy the integrity criteria.

Time		
mins	secs	
141	00	An area of glowing can be seen at the head of Specimen J as the timber substrate begins to burn through. A cotton pad is applied but fails to ignite.
142	35	Flickers of flames can now be at the head of Specimen J as the timber substrate continues to burn through.
143	10	A cotton pad is applied at the head of Specimen J and ignites. On removal of the pad a sustained flames is evident from the same location. Cotton pad and sustained flaming integrity failure of Specimen J is deemed to occur. The specimen is blanked off to allow the test to continue.
145	00	Thermocouple number 68 of Specimen I records a temperature rise in excess of 180° C. Insulation failure of Specimen I is deemed to occur.
155	00	Smoke release increases from Specimens E and F.
163	00	The steel angle substrate to Specimen L begins to bow away from the furnace chamber at the head of the specimen.
183	00	A cotton pad is applied to an area mid span of Specimen F but fails to ignite.
186	00	Thermocouple number 23 of Specimen B records a temperature rise in excess of 180° C. Insulation failure of Specimen B is deemed to occur.
197	00	A cotton pad is applied to an area mid span of Specimen F but fails to ignite.
199	45	A sustained flame spreads throughout Specimen I as the timber substrate burns through and ignites. Cotton pad and sustained flaming integrity failure of Specimen I is deemed to occur. The specimen is blanked off to allow the test to continue.
208	20	A sustained flame is visible at the head of Specimen K as the timber substrate burns through and ignites. Cotton pad and sustained flaming integrity failure of Specimen K is deemed to occur. The specimen is blanked off to allow the test to continue.
210	00	The surface thermocouples of Specimen H are temporarily exposed to hot furnace gasses venting from behind the blanking material of Specimen I.
229	00	A cotton pad is applied to Specimen F along steel edge and ignites. Cotton pad integrity failure of Specimen F is deemed to occur. The heat radiating from the steel substrate of Specimen F was the cause of cotton pad integrity failure at this point.

Time

mins secs

- 240 00** No significant visible change. All specimens excluding Specimens F, I, J and K continue to satisfy the integrity criteria.
- 242 00** The seal to Specimen A has separated from the test construction along the perimeter edge and glowing can be seen within the area of separation.
- 244 05** A cotton pad is applied to the area of glowing of Specimen A and ignites. **Cotton pad integrity failure of Specimen A is deemed to occur.**
- 246 58** An area of glowing is visible within the seal of Specimen C approximately 100 mm from the end of the seal and adjacent to thermocouple number 24. A cotton pad is applied and ignites. **Cotton pad integrity failure of Specimen C is deemed to occur.**
- 285 10** An area of glowing becomes visible within the seal of Specimen B towards the end of the seal. A cotton pad is applied but fails to ignite. Cracks begin to form within the seal of Specimen C in various places and glowing can be seen within the cracks.
- 300 00** No significant visible change. Specimens B, D, E, G, H & L continue to satisfy the integrity criteria. **The test is discontinued at the sponsor's request.**

Test Photographs

The unexposed face of the wall construction prior to testing



The unexposed face of the floor construction prior to testing



The unexposed face of the wall construction after 61 minutes of testing

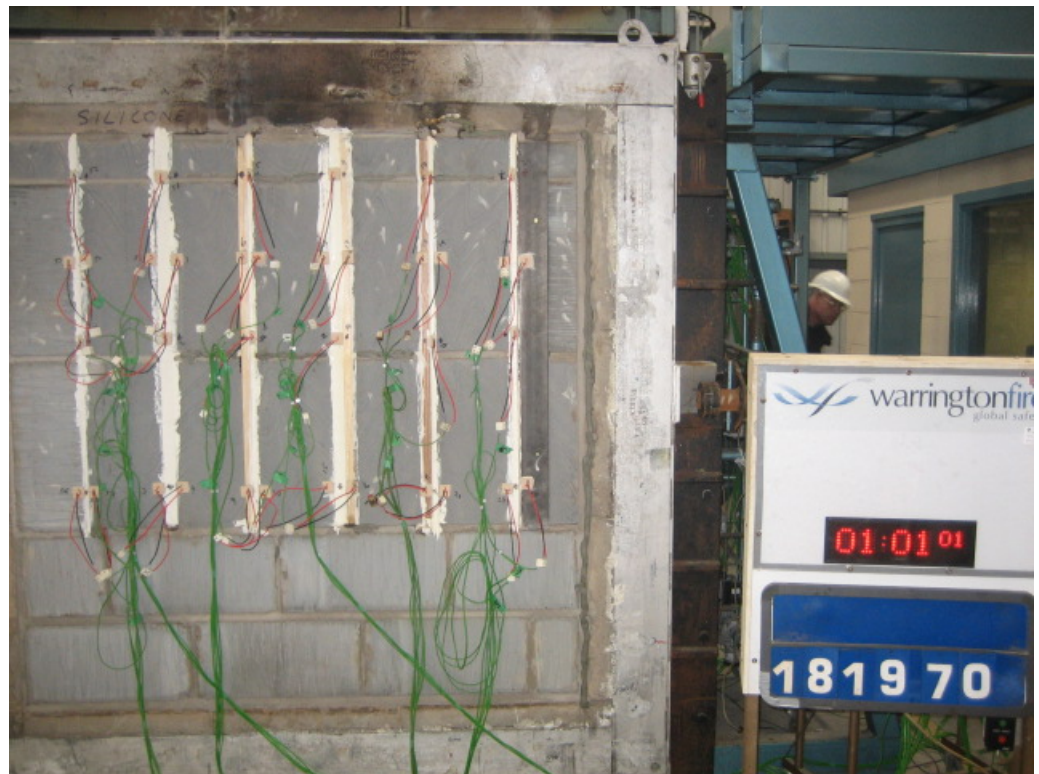

The unexposed face of the floor construction after 61 minutes of testing

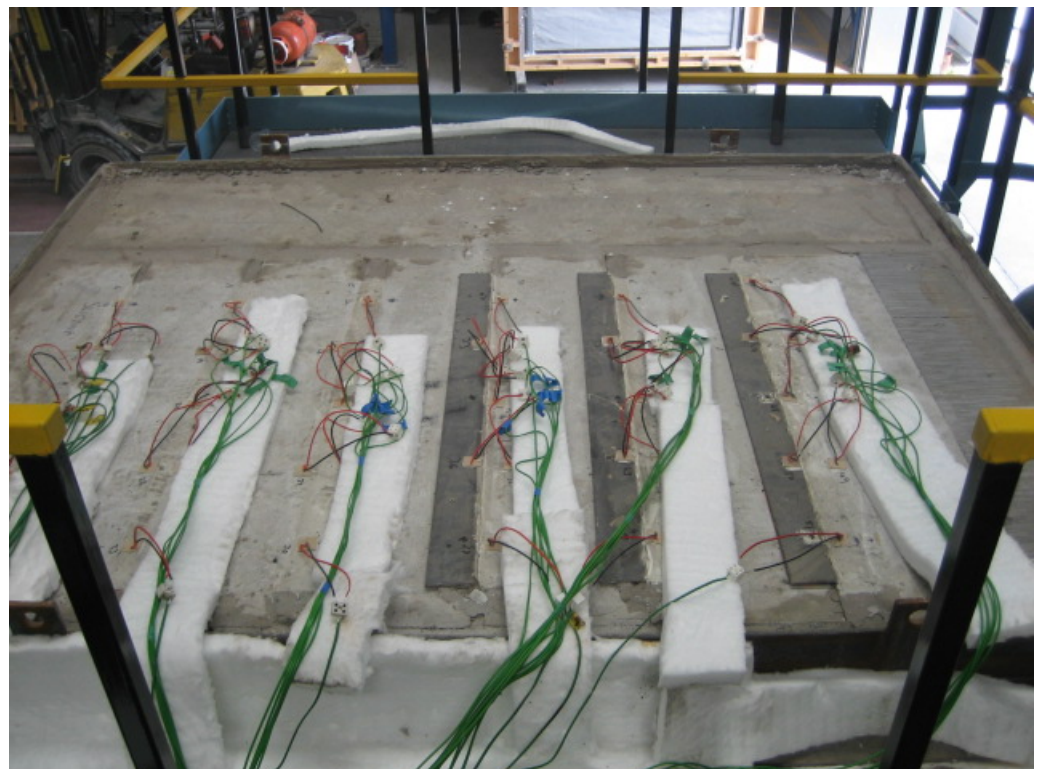

The unexposed face of the wall construction after 120 minutes of testing



The unexposed face of the floor construction after 120 minutes of testing



Integrity failure of Specimen J after 143 minutes of testing



The unexposed face of the wall construction after 184 minutes of testing



The unexposed face of the floor construction after 184 minutes of testing



Integrity failure of Specimen I that occurred after 199 minutes of testing



Integrity failure of Specimen K after 208 minutes of testing



The unexposed face of the wall construction after 240 minutes of testing



The unexposed face of the floor construction after 240 minutes of testing

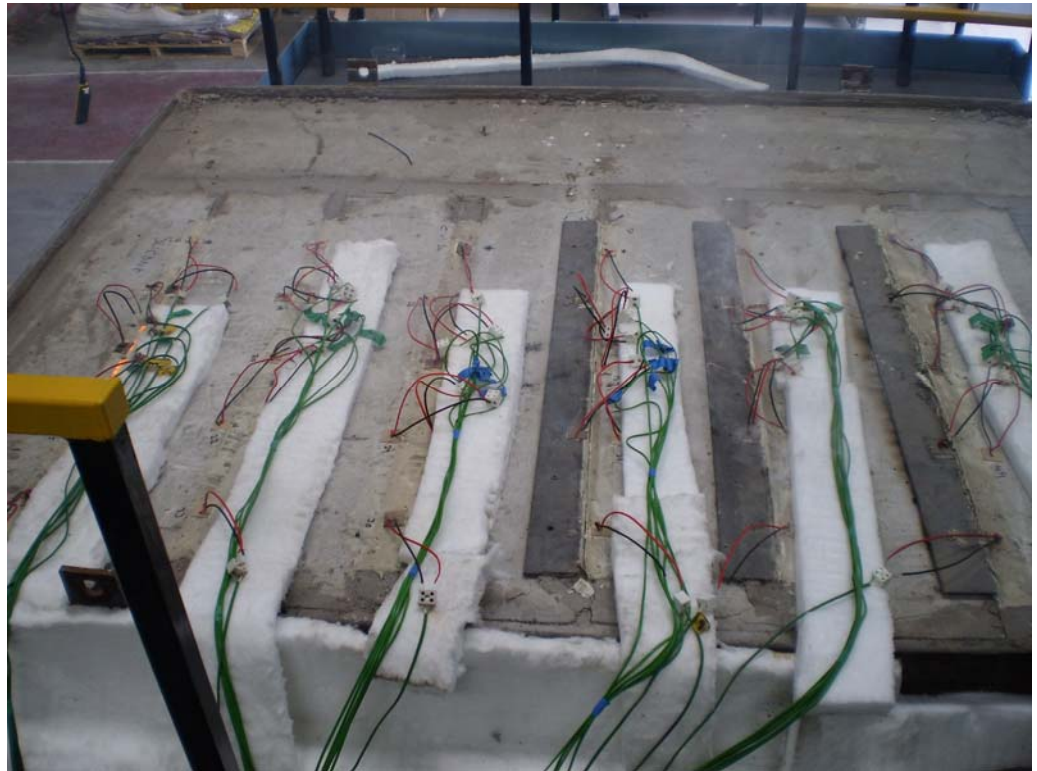

The unexposed face of Specimen A during the test

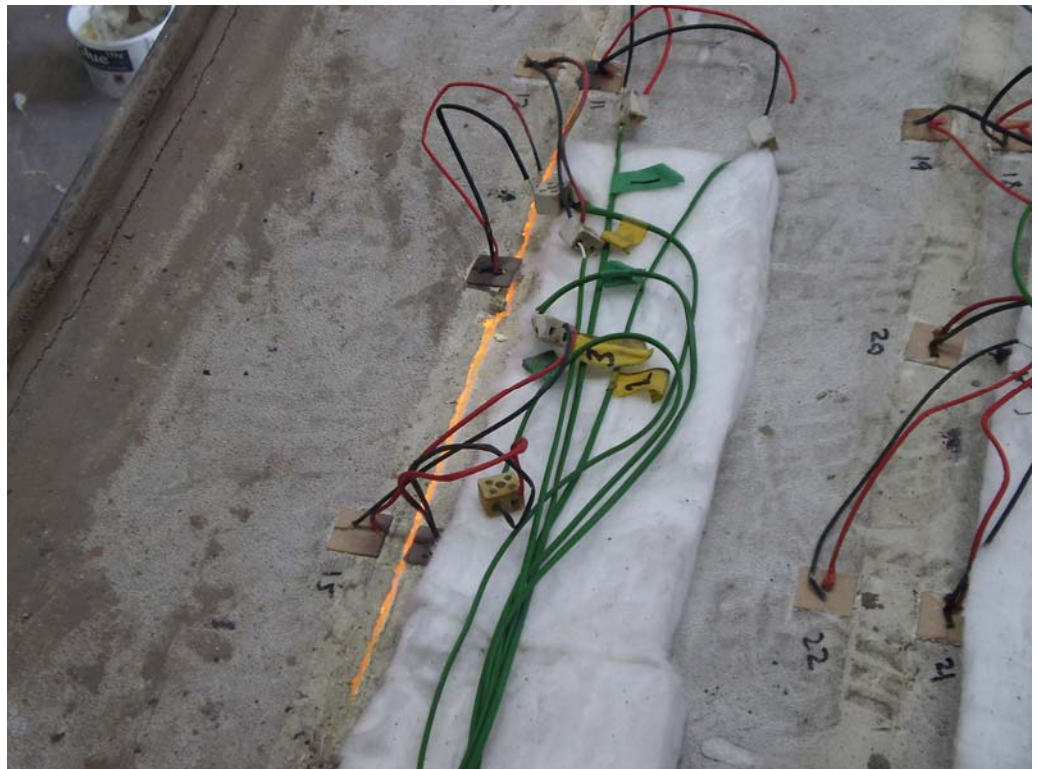

The unexposed face of the wall construction after 300 minutes of testing



The unexposed face of the floor construction after 300 minutes of testing



The exposed face
of the wall
construction
immediately after
testing



Temperature Data

Mean Furnace Temperature, Together With The Temperature/Time Relationship Specified In The Standard

Time Mins	Specified Furnace Temperature Deg. C	Actual Furnace Temperature Deg. C
0	20	30
10	678	684
20	781	782
30	842	841
40	885	881
50	918	916
60	945	942
70	968	965
80	988	985
90	1006	1002
100	1022	1016
110	1036	1031
120	1049	1045
130	1061	1057
140	1072	1068
150	1082	1077
160	1092	1085
170	1101	1097
180	1110	1106
190	1118	1113
200	1126	1120
210	1133	1127
220	1140	1133
230	1146	1140
240	1153	1147
250	1159	1152
260	1165	1159
270	1170	1166
280	1176	1172
290	1181	1177
300	1186	1180

**Individual Temperatures Recorded On The Unexposed Surface Of Specimen A
And Adjacent To Specimen A**

Time Mins	T/C Number 10 Deg. C	T/C Number 11 Deg. C	T/C Number 12 Deg. C	T/C Number 13 Deg. C	T/C Number 14 Deg. C	T/C Number 15 Deg. C	T/C Number 16 Deg. C
0	18	18	18	18	18	18	18
10	20	21	20	27	24	24	32
20	31	30	28	46	42	43	61
30	45	41	37	63	63	63	82
40	59	52	48	79	76	75	97
50	70	63	60	91	84	82	107
60	77	72	69	100	89	87	123
70	83	79	75	110	94	92	139
80	90	83	79	121	101	99	152
90	93	86	81	133	113	110	165
100	102	89	84	145	127	121	176
110	111	91	86	155	139	130	187
120	119	95	88	165	151	140	198
130	131	100	91	175	163	149	209
140	142	110	95	182	174	156	216
150	153	121	101	192	186	164	224
160	163	132	109	199	199	172	227
170	172	143	117	213	255	187	232
180	178	156	127	288	300	204	220
190	184	170	139	341	328	215	215
200	192	184	151	420	347	236	226
210	198	207	165	450	376	252	233
220	206	244	185	476	389	276	254
230	220	291	205	493	434	294	331
240	201	349	224	507	461	305	393
250	144	381	246	507	480	322	435
260	123	389	256	532	499	329	448
270	138	401	264	573	514	347	444
280	152	406	269	573	528	364	445
290	191	410	278	*	546	382	446
300	176	418	281		565	385	451

*Thermocouple malfunction

Individual Temperatures Recorded On The Unexposed Surface Of Specimen B And Adjacent To Specimen B

Time Mins	T/C Number 17 Deg. C	T/C Number 18 Deg. C	T/C Number 19 Deg. C	T/C Number 20 Deg. C	T/C Number 21 Deg. C	T/C Number 22 Deg. C	T/C Number 23 Deg. C
0	19	18	18	19	19	19	19
10	19	19	19	19	19	19	21
20	25	23	23	25	23	23	36
30	37	34	33	36	33	32	53
40	49	50	46	49	48	45	67
50	59	65	58	59	62	56	76
60	68	77	67	67	74	64	84
70	75	86	71	72	81	67	90
80	81	92	73	76	87	70	100
90	87	94	75	82	91	73	111
100	94	94	77	90	92	74	121
110	101	95	79	98	94	75	132
120	107	95	82	107	94	78	145
130	117	97	88	117	95	81	155
140	125	99	93	126	96	85	164
150	132	100	103	137	98	90	173
160	141	102	116	147	98	96	182
170	148	112	128	155	100	109	189
180	154	128	136	162	127	121	196
190	161	145	145	166	141	130	198
200	167	157	152	174	153	139	204
210	172	167	158	179	165	147	209
220	177	176	165	183	172	153	212
230	182	182	170	187	179	158	215
240	186	188	175	190	185	162	218
250	190	194	180	193	191	166	221
260	193	200	184	198	203	173	228
270	196	203	188	200	208	178	233
280	199	208	192	201	210	180	240
290	203	215	196	204	218	185	251
300	206	218	199	207	225	190	267

**Individual Temperatures Recorded On The Unexposed Surface Of Specimen C
And Adjacent To Specimen C**

Time Mins	T/C Number 24 Deg. C	T/C Number 25 Deg. C	T/C Number 26 Deg. C	T/C Number 27 Deg. C	T/C Number 28 Deg. C	T/C Number 29 Deg. C	T/C Number 30 Deg. C
0	19	19	19	20	20	20	19
10	51	26	23	37	27	25	34
20	97	56	44	72	60	49	66
30	119	79	65	95	84	71	87
40	139	88	73	111	93	79	100
50	164	100	79	125	101	84	110
60	188	122	87	151	130	94	127
70	209	149	98	186	164	113	153
80	228	172	114	222	200	137	183
90	245	191	133	248	232	160	207
100	261	216	151	266	260	176	224
110	270	239	164	278	282	187	234
120	279	243	171	286	299	197	245
130	286	259	181	292	314	204	251
140	290	267	188	299	325	210	256
150	296	265	193	305	332	217	264
160	301	271	198	311	340	222	269
170	304	279	203	316	348	227	272
180	350	278	206	322	356	233	278
190	615	290	212	324	362	235	281
200	625	294	216	329	370	240	284
210	621	295	222	335	377	244	288
220	617	305	226	338	385	247	290
230	626	310	228	339	391	250	298
240	622	313	233	344	397	254	335
250	545	322	236	353	403	258	394
260	546	324	243	375	412	265	429
270	548	334	250	400	419	274	440
280	548	350	269	450	425	280	448
290	547	383	283	446	433	287	450
300	565	394	296	455	447	295	451

**Individual Temperatures Recorded On The Unexposed Surface Of Specimen D
And Adjacent To Specimen D**

Time Mins	T/C Number 31 Deg. C	T/C Number 32 Deg. C	T/C Number 33 Deg. C	T/C Number 34 Deg. C	T/C Number 35 Deg. C	T/C Number 36 Deg. C	T/C Number 37 Deg. C
0	19	19	19	19	19	19	18
10	26	19	36	22	20	40	27
20	47	22	70	34	22	83	48
30	73	28	113	52	28	129	72
40	90	39	154	71	40	171	87
50	101	55	189	85	57	205	99
60	109	73	216	97	72	233	109
70	111	84	238	106	78	255	119
80	115	88	257	115	82	273	127
90	120	90	271	123	84	288	136
100	127	92	283	129	86	299	145
110	134	93	292	133	86	308	152
120	136	94	300	139	87	315	158
130	143	94	306	143	87	323	164
140	144	95	312	148	88	330	168
150	146	94	318	154	89	337	172
160	148	95	323	159	90	344	176
170	151	97	328	164	91	349	182
180	150	100	334	169	93	355	184
190	162	105	337	171	96	359	189
200	157	110	342	174	104	364	192
210	151	115	347	178	111	369	194
220	155	120	351	180	116	373	198
230	161	125	355	182	120	377	203
240	156	130	360	185	126	382	209
250	174	135	363	186	131	386	219
260	171	141	368	188	137	392	226
270	174	146	373	192	142	397	234
280	181	151	377	195	146	403	239
290	182	157	381	195	153	408	248
300	184	162	388	199	161	414	252

**Individual Temperatures Recorded On The Unexposed Surface Of Specimen E
And Adjacent To Specimen E**

Time Mins	T/C Number 38 Deg. C	T/C Number 39 Deg. C	T/C Number 40 Deg. C	T/C Number 41 Deg. C	T/C Number 42 Deg. C	T/C Number 43 Deg. C	T/C Number 44 Deg. C
0	20	19	20	20	19	20	16
10	31	20	36	27	20	43	9
20	55	23	78	48	22	90	51
30	82	30	128	71	30	140	73
40	102	43	172	91	42	186	95
50	117	57	210	108	57	225	114
60	131	71	243	121	71	257	118
70	139	80	267	127	80	280	123
80	147	84	286	130	85	298	124
90	157	87	302	135	89	313	122
100	168	90	315	142	90	325	118
110	177	92	326	148	93	336	122
120	183	94	334	155	97	346	126
130	192	98	343	161	103	354	127
140	198	106	351	166	109	363	139
150	203	115	356	173	116	371	136
160	209	125	362	178	123	377	145
170	219	134	368	183	131	383	146
180	223	142	372	185	139	388	154
190	237	150	378	191	147	393	158
200	241	161	383	194	156	398	163
210	242	172	387	199	165	403	165
220	253	181	393	203	175	408	167
230	261	191	398	209	184	413	168
240	264	203	402	213	194	418	170
250	270	213	406	218	204	422	177
260	274	224	410	222	217	428	182
270	285	235	415	226	232	433	191
280	291	246	420	235	249	439	201
290	293	261	426	254	268	446	214
300	296	273	432	287	289	457	264

**Individual Temperatures Recorded On The Unexposed Surface Of Specimen F
And Adjacent To Specimen F**

Time Mins	T/C Number 45 Deg. C	T/C Number 46 Deg. C	T/C Number 47 Deg. C	T/C Number 48 Deg. C	T/C Number 49 Deg. C	T/C Number 50 Deg. C	T/C Number 51 Deg. C
0	18	19	19	20	19	19	18
10	25	20	57	26	20	54	26
20	42	27	120	46	25	112	50
30	61	43	179	73	36	165	73
40	75	61	231	93	51	215	91
50	87	78	280	107	67	266	105
60	98	88	317	122	80	306	120
70	107	93	344	132	87	335	133
80	113	95	365	136	92	358	144
90	119	97	384	140	95	377	157
100	126	97	399	146	96	392	168
110	129	98	412	151	97	404	176
120	134	99	423	161	98	417	186
130	140	107	434	168	100	430	190
140	148	133	449	182	100	443	199
150	155	150	471	192	105	458	206
160	159	163	496	200	125	472	211
170	164	179	521	211	146	488	214
180	171	188	544	225	156	505	227
190	180	202	568	240	166	522	233
200	184	214	590	253	175	538	239
210	191	225	608	276	184	551	241
220	201	237	624	315	191	562	254
230	211	251	640	347	200	573	258
240	225	255	648	358	208	584	269
250	241	267	649	355	213	586	272
260	256	270	645	344	220	580	271
270	268	275	643	336	227	571	275
280	281	281	641	331	231	563	282
290	290	282	637	326	230	556	288
300	297	287	633	321	234	552	308

**Individual Temperatures Recorded On The Unexposed Surface Of Specimen G
And Adjacent To Specimen G**

Time Mins	T/C Number 52 Deg. C	T/C Number 53 Deg. C	T/C Number 54 Deg. C	T/C Number 55 Deg. C	T/C Number 56 Deg. C	T/C Number 57 Deg. C
0	17	17	17	17	17	17
10	18	18	18	18	18	18
20	19	18	18	18	18	18
30	25	20	20	19	18	18
40	33	25	25	23	19	19
50	40	32	30	30	23	23
60	46	40	36	38	29	29
70	51	47	43	47	37	37
80	59	55	50	57	45	43
90	64	62	56	65	53	50
100	68	70	62	68	58	55
110	73	76	70	70	64	60
120	75	79	73	72	68	64
130	76	80	75	73	70	66
140	78	82	76	74	72	67
150	79	83	77	76	73	68
160	81	84	79	77	74	69
170	83	84	80	80	74	70
180	85	85	81	83	74	70
190	89	85	83	87	75	71
200	93	86	84	91	75	72
210	99	86	86	95	75	73
220	105	87	87	102	76	74
230	110	86	88	107	77	75
240	117	87	89	115	78	77
250	123	87	90	121	79	79
260	130	88	91	128	81	80
270	137	90	92	136	82	81
280	144	91	94	142	83	83
290	151	95	96	150	84	84
300	159	102	104	156	86	86

Individual Temperatures Recorded On The Unexposed Surface Of Specimen H And Adjacent To Specimen H

Time Mins	T/C Number 58 Deg. C	T/C Number 59 Deg. C	T/C Number 61 Deg. C	T/C Number 62 Deg. C	T/C Number 63 Deg. C	T/C Number 64 Deg. C
0	17	17	17	16	17	17
10	18	18	19	18	19	19
20	18	18	19	19	19	19
30	19	18	19	19	19	19
40	20	19	20	19	20	20
50	25	19	20	20	21	21
60	37	22	22	23	24	22
70	45	25	25	27	31	26
80	51	30	30	32	34	31
90	56	36	36	38	41	37
100	60	41	41	44	44	42
110	64	46	47	49	52	50
120	66	51	52	52	58	56
130	66	54	56	55	61	58
140	67	57	59	58	62	60
150	71	60	64	63	64	62
160	69	61	63	66	66	64
170	69	63	64	69	68	66
180	69	64	65	72	71	68
190	71	66	66	76	74	71
200	76	68	69	80	76	74
210	96	*	*	*	78	76
220	84	78	81	99	80	79
230	85	74	77	90	82	81
240	89	76	78	91	85	84
250	93	77	79	95	85	86
260	96	78	79	98	87	87
270	100	79	81	102	89	89
280	105	81	82	108	92	90
290	110	82	83	114	93	91
300	117	83	85	120	95	91

*Temporary thermocouple malfunction

**Individual Temperatures Recorded On The Unexposed Surface Of Specimen I
And Adjacent To Specimen I**

Time Mins	T/C Number 65 Deg. C	T/C Number 66 Deg. C	T/C Number 67 Deg. C	T/C Number 68 Deg. C	T/C Number 69 Deg. C	T/C Number 70 Deg. C
0	16	17	17	17	17	17
10	19	19	19	19	19	19
20	20	19	20	21	19	19
30	28	20	23	27	19	19
40	38	23	29	36	21	21
50	42	26	33	48	23	24
60	45	29	39	69	26	29
70	47	35	50	84	29	34
80	52	42	61	94	33	38
90	60	54	75	105	37	44
100	68	66	84	119	41	49
110	75	73	91	135	47	56
120	78	78	95	153	57	66
130	86	83	101	172	64	78
140	92	90	118	189	67	83
150	94	97	153	209	70	86
160	103	32	143	233	74	88
170	113	33	154	231	77	89
180	122	34	166	241	81	90
190	132	34	181	259	83	93
197	140	36	191	277	90	94
198	141	36	194	283	91	94
199	#	#	#	#	#	#

#Specimen blanked off to allow test to continue

**Individual Temperatures Recorded On The Unexposed Surface Of Specimen J
And Adjacent To Specimen J**

Time Mins	T/C Number 71 Deg. C	T/C Number 72 Deg. C	T/C Number 73 Deg. C	T/C Number 74 Deg. C	T/C Number 75 Deg. C	T/C Number 76 Deg. C
0	16	17	17	17	17	17
5	19	19	19	20	19	20
10	19	19	19	19	19	20
15	19	19	19	19	19	19
20	20	19	19	19	20	19
25	21	19	19	19	20	20
30	22	19	19	20	20	20
35	23	19	19	21	21	20
40	25	20	20	22	22	21
45	27	20	21	22	22	21
50	29	21	22	24	23	22
55	31	22	23	25	23	22
60	35	23	24	27	25	22
65	40	24	26	29	26	24
70	48	25	27	30	28	25
75	61	27	30	32	29	28
80	72	29	33	34	31	35
85	80	32	38	36	33	40
90	87	35	41	38	35	43
95	93	39	45	40	37	45
100	98	43	49	43	41	48
105	102	48	52	46	43	51
110	106	53	56	49	47	54
115	111	59	60	52	49	56
120	118	64	67	55	52	58
125	125	68	84	58	54	59
130	133	73	95	61	56	60
135	141	76	95	63	58	60
140	151	80	96	66	61	62
142	157	81	96	67	63	62
143	#	#	#	#	#	#

#Specimen blanked off to allow test to continue

**Individual Temperatures Recorded On The Unexposed Surface Of Specimen K
And Adjacent To Specimen K**

Time	T/C	T/C	T/C	T/C	T/C	T/C
Mins	Number	Number	Number	Number	Number	Number
	77	78	79	80	81	82
	Deg. C	Deg. C	Deg. C	Deg. C	Deg. C	Deg. C
0	17	17	17	17	17	17
10	19	19	19	19	38	20
20	20	19	20	19	35	20
30	31	20	21	20	36	22
40	44	22	23	23	41	24
50	49	25	27	27	45	27
60	48	29	32	34	50	31
70	58	34	40	41	54	36
80	70	59	51	48	59	41
90	77	60	63	55	62	46
100	82	61	72	61	64	50
110	87	65	80	65	66	56
120	92	68	83	69	67	60
130	98	72	85	72	68	63
140	105	74	86	76	68	67
150	113	77	87	79	69	71
160	125	82	90	82	71	76
170	137	89	92	86	72	79
180	151	94	96	92	75	82
190	167	101	112	99	77	84
199	181	114	129	107	79	85
206	192	144	142	113	80	85
207	194	152	144	115	81	85
208	#	#	#	#	#	#

#Specimen blanked off to allow test to continue

**Individual Temperatures Recorded On The Unexposed Surface Of Specimen L
And Adjacent To Specimen L**

Time Mins	T/C Number 83 Deg. C	T/C Number 84 Deg. C	T/C Number 85 Deg. C	T/C Number 86 Deg. C	T/C Number 87 Deg. C	T/C Number 88 Deg. C
0	18	18	19	19	18	19
10	26	20	31	29	21	33
20	46	24	61	51	24	63
30	68	32	94	78	30	97
40	93	46	124	104	42	128
50	109	57	151	117	53	156
60	117	66	175	131	64	179
70	125	74	194	144	73	200
80	137	81	211	159	81	218
90	149	86	226	173	87	234
100	161	90	240	184	91	249
110	169	93	253	194	93	262
120	179	95	264	202	94	274
130	186	97	275	210	95	285
140	194	102	285	219	97	295
150	200	107	293	224	99	303
160	206	111	301	231	102	311
170	211	115	308	235	107	318
180	214	118	315	239	112	325
190	218	121	322	243	118	331
200	223	126	328	247	123	338
210	227	129	334	251	128	343
220	232	133	339	255	133	349
230	233	135	345	256	136	354
240	238	138	351	260	142	360
250	241	141	355	262	144	364
260	244	145	360	266	147	369
270	250	151	365	272	151	374
280	252	152	371	274	156	380
289	254	156	376	277	158	384
300	258	160	382	281	162	390

Table Showing Recorded Furnace Pressure at mid height of the wall assembly

Time Mins	Recorded Pressure Pascals
0	0.0
10	15.8
20	16.2
30	14.6
40	14.6
50	15.0
60	13.9
70	14.6
80	14.1
90	14.8
100	13.2
110	14.8
120	14.6
130	14.0
140	15.2
150	15.2
160	13.9
170	14.4
180	14.3
190	14.6
200	14.0
210	13.1
220	13.7
230	15.2
240	15.1
250	13.1
260	13.8
270	15.1
280	15.0
290	14.5
300	14.4

Graph Showing Mean Furnace Temperature, Together With The Temperature/Time Relationship Specified In The Standard

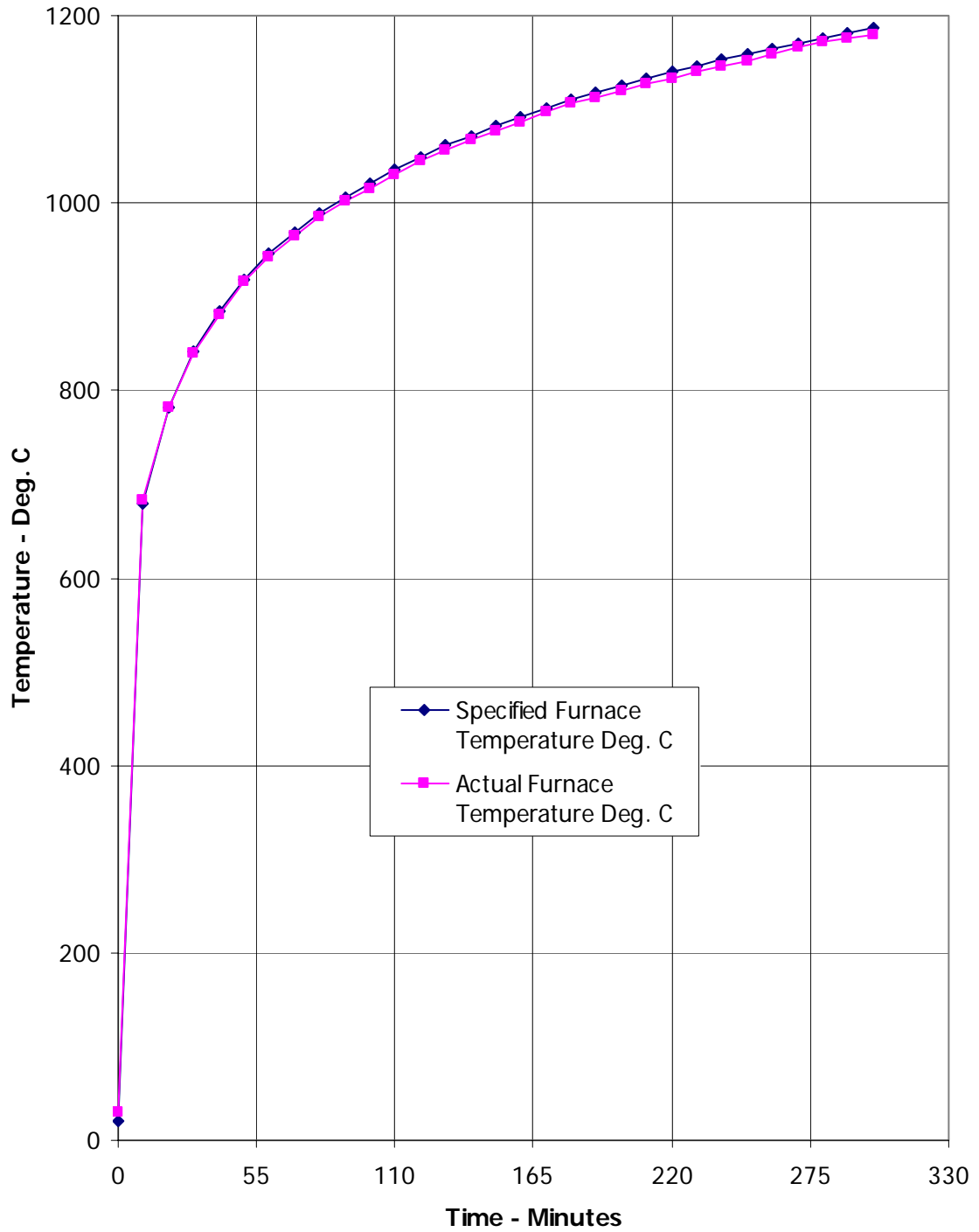

Performance Criteria and Test Results

Integrity

It is required that the specimen retains its separating function, without either causing ignition of a cotton pad when applied as specified in BS EN 1363-1: 1999, or resulting in sustained flaming on the unexposed surface. **These requirements were satisfied for the periods shown below:**

Specimen	Integrity (minutes)	
	Cotton pad	Sustained flames
A	244	300*
B	300*	300*
C	246	300*
D	300*	300*
E	300*	300*
F	229	300*
G	300*	300*
H	300*	300*
I	199	199
J	143	143
K	208	208
L	300*	300*

Insulation

The requirements of the standard are that the maximum temperature rise shall not be greater than 180°C. Insulation failure also occurs simultaneously with integrity failure as specified in BS EN 1363-1: 1999. **These requirements were satisfied for the periods shown below:**

Specimen	Insulation (minutes)
A	122
B	186
C	65
D	48
E	43
F	33
G	300*
H	300*
I	145
J	143
K	208
L	69

* The test duration. The test was discontinued after a period of 300 minutes.

Ongoing Implications

Limitations

The results relate only to the behaviour of the specimens of the element of construction under the particular conditions of test. They are not intended to be the sole criteria for assessing the potential fire performance of the element in use, nor do they reflect the actual behaviour in fires.

The results may not be applicable to situations where the joint widths, sealant depths, orientations, supporting construction and backing material vary from those tested.

This test report is additional to that issued as WF Report No. 181970 and dated 1st May 2009. The original test report remains valid and is not replaced by this additional test report. The product which was the subject of the test has not been retested and this additional report does not involve any technical change or technical review of the original test report. Details of the original product name and sponsor of the test are documented by warringtonfire and are maintained in confidential company records.

Conclusions

Evaluation against objective

A fire resistance test has been conducted to assess the ability of six wall mounted and six floor mounted specimens of linear joint sealing systems, to reinstate the integrity and insulation performance (as defined in BS EN 1366-4: 2006) of a simulated wall construction, where adjacent structures abut.

Test Results:

Reference	Integrity (mins)		Insulation (mins)
	Cotton Pad	Sustained flaming	
A	244	300*	122
B	300*	300*	186
C	246	300*	65
D	300*	300*	48
E	300*	300*	43
F	229	300*	33
G	300*	300*	300*
H	300*	300*	300*
I	199	199	145
J	143	143	143
K	208	208	208
L	300*	300*	69

* The test duration. The test was discontinued after a period of 300 minutes.

Field of Direct Application

Orientation The field of application regarding the orientation of the linear joint is given in Table 1.

Table 1 – Field of application regarding orientation

Tested orientation	Application
A	A, D, E ^a
B	B
C	C, D ^b
^a Orientation E will only be covered by test orientation A if shear movement was chosen and one face of the joint was fixed and the other face was moved. ^b Orientation D will only be covered by test orientation C if shear movement was chosen and one face of the joint was fixed and the other face was moved.	

Key

- A. Linear joint in a horizontal test construction.
- B. Vertical linear joint in a vertical test construction.
- C. Horizontal linear joint in a vertical test construction.
- D. Horizontal wall joint abutting a floor, ceiling or roof.
- E. Horizontal floor joint abutting a wall.

Table 1 only applies when both the supporting construction and the location of the seal within the linear joint remain unchanged.

Supporting construction

Test results obtained with autoclaved aerated concrete standard supporting constructions apply to concrete, block work and masonry separating elements of a thickness and density equal to or greater than that tested.

Test results obtained with timber standard supporting construction apply to timber separating elements of a thickness and density equal to or greater than that tested.

Test results obtained with the steel angle standard supporting construction apply to separating element constructions made of metals with a melting point higher than 1000 °C.



Seal position

Test results are valid only for the position in which the seal was tested, except that where the linear joint seal was fitted flush with the surface of the supporting construction and is exposed to the fire.

Mechanically induced movement

The linear gap sealing systems were not tested for mechanically induced movement, therefore the movement capability of the linear joint seal must be less than $\pm 7.5\%$



Bodycote warringtonfire • Head Office • Holmesfield Road • Warrington • Cheshire • WA1 2DS • United Kingdom
Tel: +44 (0) 1925 655 116 • Fax: +44 (0) 1925 655 419 • Email: Info@warringtonfire.net • Website: www.warringtonfire.net

